

Tragfähigkeit

250 kg

Flanschbreite

42 mm - 120 mm

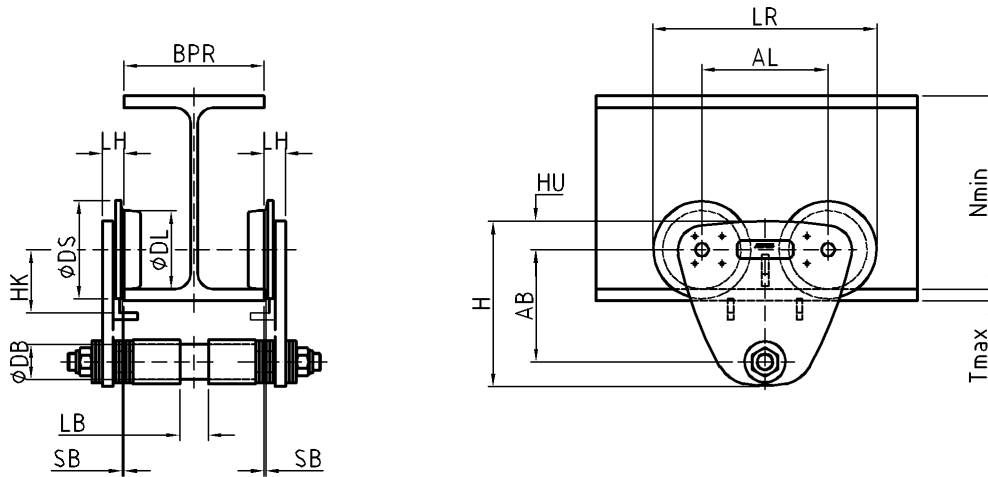

Maße und Gewichte

AL	90 mm	AB	85 mm	DS	75 mm		
DL	56 mm	DB	22 mm	HU	29 mm		
H	135 mm	HK	47 mm	LR	165 mm	N _{min}	110 mm
LB	20 mm	LH	17 mm				
SB _{max}	2 mm	T _{max}	20 mm				

Gewicht Fahrwerk 3,9 kg

BPR _{min}	BPR _{max}	Kurvenradius
42 mm	70 mm	>= 600 mm
71 mm	85 mm	>= 700 mm
86 mm	120 mm	>= 1000 mm

ABUS Kransysteme GmbH
 Sonnenweg 1
 51647 Gummersbach

Fahrwerk HF03

30.10.2012